

Owner's Manual **MOBILE THEATER**

Double Din DVD Player, AM/FM, TV with
Motorized 6.5" Wide TFT LCD Display



PYLE®
view

PLTNV66

www.pyleaudio.com

Congratulations on purchasing this model.

Make sure to read through the manual before using it.

Keep the manual within reach of your hand, as it is necessary to refer to it when using it.

Table of the Contents

1. Precautions -----	5	■ Using the Touch Screen -----	19
■ Cautions for Safety -----	5	■ Exchanging the Remote Control Battery -----	19
■ Cautions before Using -----	6	5. Operating Basic Functions -----	20
■ Cautions when Using -----	6	■ Radio Functions -----	20
2. Before using this Unit -----	7	■ TV Functions -----	23
■ Disc -----	7	■ Disc Playback Functions -----	26
■ Navigation(OPTION)-----	8	■ Navigation system(OPTION)-----	35
3. Names of Parts -----	9	■ External Functions -----	36
■ Display -----	9	■ Bluetooth Functions(OPTION) -----	37
■ Remote Control -----	12	6. Detailed Function Operations -----	40
4. Basic Operations -----	17	■ Main Setup -----	40
■ Power on/off -----	17	■ Sound Setup -----	41
■ Source Selection -----	17	■ DVD Setup -----	47
■ Volume Adjustment -----	17	■ ETC Setup -----	53
■ Muting the sound -----	18	■ Zone Setup -----	54
■ Adjusting the LCD Panel Angle-----	18	■ Adjusting touch Sensitivity of LCD Panel -----	55
■ Inserting/Ejecting Disc -----	18	7. Appendix -----	56
■ Switch on/off LCD Monitor -----	19	■ Troubleshooting -----	56

Table of the Contents

■ Specifications	59
■ Installations & Connections	61
■ Components	68

1. Precautions

■ Cautions for Safety

Do not use this unit when it is out of order or in trouble.

Do not turn it on when it shows abnormal picture and/or does not sound. Stop this unit immediately when it is dusted, emits smoke, or smells, which will cause an accident, fire, or electric shock. Contact the vendor of this unit or authorized after-sales service center.

Power supply of 12V for car is used for this unit.

This unit is designed to be connected to the power supply (12V) of your car. Do not forget to use the power connector supplied in your package. If any other connector is used, this unit breaks down or severe trouble may occur.

Take precautions not to break any parts of your car.

Pay attention not to damage any components (electric devices, wiring, pipes, screws, etc) of your car, when this unit is installed. Otherwise, they can be easily damaged, which would cause your car out of control, fire, electric shock, and traffic accident, etc.

Do not disassemble or remodel randomly.

If your this unit is disassembled or remodeled at your discretion, there would be any accidents such as fire, electric shock, as well as the damage to your car. In this condition, it can not be covered with after-sales service and it is a violation to FCC rules.

Adjust to the adequate sound volume.

An excessive sound volume may bring a cause to the car accident, with the sound from outside not being able to hear. Therefore, the sound volume should be to the level that you can hear the sound from outside of your car.

Authorized components only should be used.

Use only designated parts. Unauthorized components would bring damage to this unit or hinder the installation and operation. All the responsibility is subject to the user when any problem arises from inadequate components. When any supplied parts are lost or damaged, purchase them from your dealer or after-sales service center of your area.

Protect this unit from humidity and any liquid, and do not block ventilation hole.

When this unit gets wet with humidity and liquid, breakdown or fire would be caused. Pay attention not to have ventilation blocked. When this unit is not ventilative, the heat is accumulated, which will cause breakdown and fire.

Do not cut the cable or remodel randomly.

Power connector has a fuse in it to protect the excessive electric current. When this fuse is removed from the cable by cutting the cable at your discretion, the protective circuit may not operate correctly or there will be a fire, or breakdown to this unit.

Do not operate or watch your TV/Monitor while driving.

Never operate and/or watch this unit when you drive your car. Your careless driving not to look at the front will bring severe car accidents. Make sure to operate them, only when you park in a safe place.

■ **Cautions before Using**

Install this unit correctly.

Refer to the power supply and system connections in the User's Manual carefully before using this unit, and operate it only after the installation is made appropriately.

Operate this unit only when your car is ignited.

Make sure to use this unit when you drive your car. When it is used for a long period of time without your car ignited, the battery would be discharged.

Set up all the functions of navigation before starting to drive.

Drive only after you complete all operations of the navigation functions such as designating route and search, etc. In case you want to change route, pull over your car in a safe place and change the route.

Make sure to use the authorized antenna.

Only use the authorized antennas for navigation. For the optimal reception, the navigation antenna should be put more than 30cm from the navigation system

in your car. The antenna cable should not be damaged when the antenna is put outside of your car.

■ **Cautions when Using**

This unit is designed to operate within -10°C to 60°C.

This unit should be operated in the temperature range from -10°C to 60°C. It would be damaged when operated in the excessive high or low temperature unreasonably. For the LCD panel, its picture can be seen slightly darkish, when using it in the low temperature of winter time. It will be a normal picture after a few minute operation. Do not use this unit right after the heater is on in the low temperature in your car. There may be a malfunction or damage to it, with humidity on the disc surface or optical lens.

Take good care of LCD and Touch Panel.

Avoid giving shock to LCD panel and keep it away from the cigarette light, which can damage it. Do not press the case around the touch panel forcefully, which can lead to its malfunction or damage, too.

Observe the traffic regulations on the road.

Because of the change of the traffic regulations, there is a possibility that the information being guided from the navigation can be different from that of the actual condition on the road. Make sure to drive, paying attention to the present road condition.

2. Before using this unit

■ Disc

1) Playable Disc

DVD Video Disc



Single-sided or both-sided

DVD Video recorded on DVD-R, DVD-RW, DVD+R, DVD+RW



Audio CD and MP3 CD recorded on CD-R, CD-RW, VCD



2) Color Monitor System

DVD player can only play discs of NTSC or PAL, not play discs of SECAM.

3) DVD Area Code

DVD Video System assigns the area code to DVD Video Players and DVD Discs, according to the areas where they are sold. For example,

DVD Video Players that are sold in U.S.A. can only play discs with the correct number('1' and 'ALL' or any combination of numbers including '1') The DVD region number is indicated on the disc as shown below.



Please, refer to the provided manual in the DVD Title which you purchased for the detailed information of area codes per country.

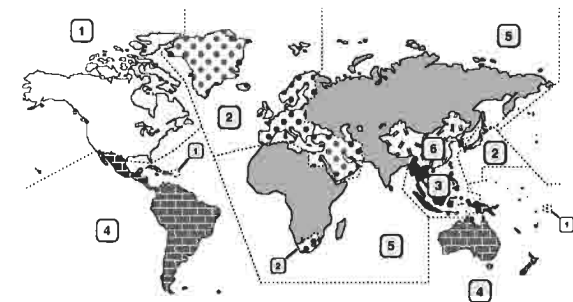

4) Handling Discs

- Do not use discs with rough edges. Using such discs could cause the product to malfunction or be damaged.
- Do not attach labels to the disc surface or mark it with a pencil or a pen. Doing so could cause the product to malfunction or be damaged.
- Do not use discs if they have scotch tape or other adhesive materials or traces of such material on them. Using such discs could cause the product to malfunction or be damaged.
- Do not use discs that are badly scratched, deformed or cracked. Using such discs could cause the product to malfunction or be damaged.
- Do not use commercially available CD protectors or disc stabilizers. Doing so could cause the product to malfunction or be damaged.
- Do not touch the disc surface when inserting or removing the disc.

5) Cleaning Discs

- Use a soft cloth to wipe the disc from the center out towards the circumference.
- Do not use any cleaner, static-proof spray, or thinner on the disc. The discs can be damaged.

6) Keeping Discs

- Do not keep discs in places where it is too hot or too cold. Doing so could deform them. Using deformed discs could cause the product to malfunction or be damaged.
- Do not keep discs in places exposed to direct sunlight or close to heaters. Doing so could deform the discs. Using deformed discs could cause the product to malfunction or be damaged.
- Do not keep discs in places that are too dusty or humid. Using discs stored in such places could cause the product to malfunction or be damaged.

■ Navigation (OPTION)

1) Car Navigation System

GPS(Global Positioning System) is a system in which the location and driving route of traveling vehicles is indicated on the electronic map of the monitor, by the radio wave that is shot from the satellites, so that drivers can drive more easily and conveniently. The method of triangulation is used to position cars are traveling. It is able to determine the latitude and longitude of a receiver on Earth by calculating the time difference for signals from different satellites to reach the receiver. For exact location, the radio wave should be received from more than 4 satellites.

3. Names of Parts

■ Display

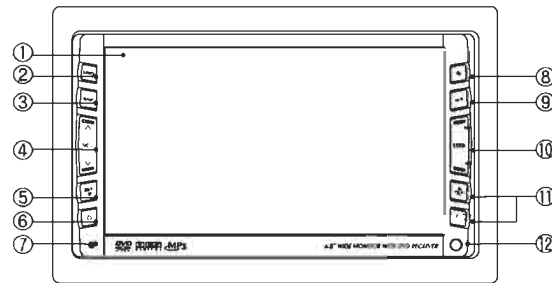

① 6.5" Wide TFT LCD Touch Screen

Video signal is shown onto 6.5" Wide TFT LCD Touch Screen

Menu icons on the LCD Screen can be operated directly with touch screen.

Touch the Screen when powered off, it will be on.

Built-in Navigation system and the navigation system connected to this unit through RGB input can be operated by touch-screen.

② [MUTE] Button

Press this button to mute the sound.

Press it once again to listen to the sound.

③ [NAVI] Button

-Short press : To change to Navi mode. Press it once again to return to the previous mode.

-Long press : To turn on navigation voice. Press it once again for that long to stop the navigation voice. (This service is available only built-in navigation system and external navigation system connected through RGB Input)

[Note] - About how NAVI button works

NAVI function should be set to "Navi on" on SET UP-ETC-EXTERN-EXT3 MODE to operate the button.

[Note] - About the function of Navigation Voice

When you change the source while Navigation is in service, the video and audio will be changed accordingly. When the Navigation voice is on, the current sound stops for a while, the navigation voice starts automatically.

④ [VOL] Button

Press it to adjust volume. The volume is adjusted 32 steps from 0 to 31.

Press [^] button to increase the volume.

Press [v] button to decrease the volume.

⑤ [SETUP] Button

-Short press : To show the system setup menu.

-Long press : To turn off the LCD screen. The sound will be still on. Touch the screen or press it shortly to turn on the LCD screen back.

⑥ [POWER/SOURCE] Button

-Short press : To turn the power on when the power is off.

-Long press : To turn the power off when the power is on.

-Short press : To change the mode as below when the power is on.

Order of source circulation :

Radio →TV→DVD→(NAVI)→EXTERN→(BLUETOOTH)→ Radio

TV Source is indicated only on TV tuner built-in model.

NAVI mode is indicated only when NAVI mode is selected on SETUP page.

(This function is limited only to the Navigation built-in model or external Navigation system is connected to this unit.)

BLUETOOTH mode is indicated only on Bluetooth built-in model.

⑦ Bluetooth Handsfree MIC(Microphone - OPTION)

It is used for the Bluetooth built-in models.

It functions as a microphone when you talk using Bluetooth built-in mobile phone (separately sold).

⑧ [EJECT] Button

Press this button to eject discs from this unit.

⑨ [PLAY/PAUSE] Button

This button can be used on each mode as below.

Radio/TV mode :

-Short Press : To scan all stations/channels. When it reaches to a strong signaled station/channel, it will stop for 5 seconds at the station/channel and the scanning will continue. Press it to stop the scanning when it reaches to your desired station/channel.

-Long Press : To scan all broadcastings and memorize strong signaled stations/channels in preset channels automatically. After preset memorization is completed, the preset stations/channels will be on for 5 seconds for each station/channel. Press it once again to stop the scanning when it reaches to your desired station/channel.

DVD :

-Short Press : To play/pause the discs.

-Long Press : To stop the discs. Press it once again to resume the playback.

Bluetooth (OPTION) :

-Short Press : To play/pause the MP3 file from the Bluetooth mobile phone(separately sold)

-Long press : To stop the MP3 playback.

[Note] About the MP3 Function of Bluetooth Mobile Phone

Bluetooth mode is available only to built-in Bluetooth model. And you should have the Bluetooth mobile phone with built-in MP3 player.

⑩ [SEEK] Button

These buttons can be used on each mode as below.

Radio/TV

Press this button to seek to the previous/next stations/channels.

DVD/MP3/CD

-Short press : To go to the previous/next track/chapter of disc forward/backward.

[Note]

When [SEEK MODE] is set to [MANUAL], press this button to seek to the previous/next step.

-Long press : To seek forward/backward at high speed. The playback speed will change as below.

2X → 4X → 8X → 32X → normal playback.

Bluetooth (OPTION)

Press this button to go to the previous/next MP3 file.

⑪ [TILT] Button

Short Press : To tilt the LCD Panel with one step up/down.

Long press : To tilt the LCD Panel continuously up/down while the button is pressed.

If this unit has built-in navigation system, you can remove the map memory card from this unit after tilting the LCD Panel down completely using this button.

⑫ Remote Control Receiver

It receives the signal of the remote control.

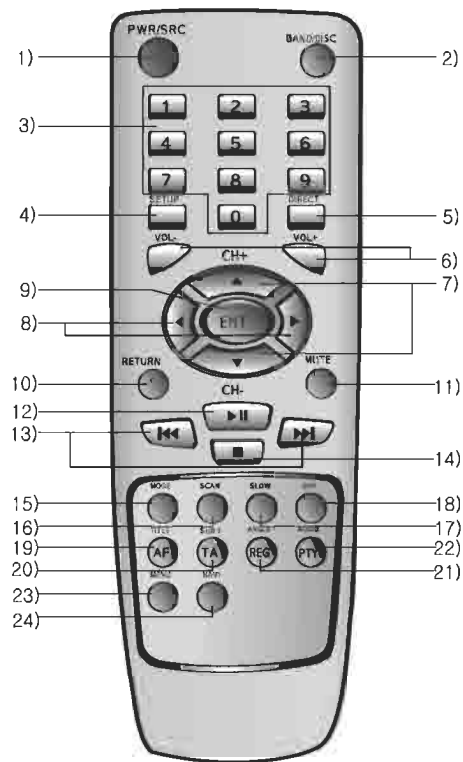

■ Remote Control

[Note] About the Use of Remote Control

If you have other equipment with remote control in your car, they can be malfunctioned if you use the remote control of this unit.

1) [PWR/SRC] Button

The functions are the same as the [POWER/SOURCE] button on the main unit.

2) [BAND/DISC] Button

Radio/TV/EXTERN

-Short press : To change the mode as below

Radio : FM1 → FM2 → FM3 → AM1(MW) → AM2(MW)

TV : TV1 → TV2

EXTERN : EXT1 → EXT2(CAM) → (EXT3)

[Note] **EXT2 will be displayed as CAM when "REAR CAM ON" is selected on SETUP-ETC-EXTERN-EXT2 MODE.

If this unit has built-in Navigation system and "NAVI ON" is selected on SETUP-ETC-EXTERN-EXT3, EXT3 will not be displayed.

-Long press : To change the [SEEK MODE] AUTO or MANUAL on Radio/TV mode.

3) [Number] Buttons

RADIO/TV :

-Short press : To select from the preset memorized stations/channels. Only preset no. 1 to 6 are available.

-Long press : To memorize the current station/channel to the pressed number.

Only buttons no. 1 to 6 are available.

DVD/MP3/CD/VCD :

Press the desired chapter/track numbers and the chapter/track selection board will be displayed on the screen. And select the chapter/track number and enter to play the selected chapter or track number.

4) [SETUP] Button

Press this button to display the [SETUP] screen.

Press it once again to remove the [SETUP] screen from the screen.

5) [DIRECT] Button

RADIO/TV : Press this button to display the frequency/channel selection board to go to the desired frequency/channel directly.

DVD/MP3/CD : Press this button to display the time selection board to go to the desired playback time directly.

6) [VOLUME] Buttons

Press these buttons to increase/decrease Volume.

7) [▲ ▼] Buttons

RADIO/TV : Press these buttons to go to the preset memorized stations/channels.

DVD : Press these buttons to move the cursor up and down to select the desired items on the DVD Setup menu.

MP3 : Press these buttons to move the cursor up and down to select the desired MP3 song and press ENT button to play the selected song.

NAVI : Press these buttons to move the map up and down.

8) [◀ ▶] Buttons

DVD : Press these buttons to move the cursor left and right to select the desired items on the DVD Setup menu.

MP3 : Press these buttons to move the cursor to the previous/next page to select the desired MP3 song and press ENT button to play the selected song.

NAVI : Press these buttons to move the map left and right.

9) [ENT] Button

Press this button to confirm the selected items for each setting.

10) [RETURN] Button

Press this button to return to the playback. When you pressed the [TITLE] button or [MENU] button on DVD mode to see the [TITLE] menu or [ROOT MENU] after selecting the desired items, press it to return to the playback.

11) [MUTE] Button

Press this button to mute the sound.
Press it once again to listen to the sound.

12) [PLAY/PAUSE] Button

The functions are the same as the [PLAY/PAUSE] button on the main unit.

13) [SEEK] Button

The functions are the same as the [SEEK] buttons on the main unit.

14) [STOP] Button

Press this button to stop playing CD/VCD/MP3/DVD Disc. Press the PLAY/PAUSE button once again to resume the playback. Press this button twice and then press the PLAY/PAUSE button, and the source will begin to play from the beginning.

15) [MODE] Button

Press this button to change DVD/CD/VCD playback mode as below

DVD : D.RPT(ALL)→RDM(RANDOM)→NORMAL→RPT(CHAPTER)→ RPT (TITLE)

CD/VCD : D.RPT(DISC REPEAT) → RDM(RANDOM) → NOR(NORMAL) → RPT(REPEAT TRACK)

MP3 : F.RPT(REPEAT FOLDER) → RDM(RANDOM) → NORMAL → RPT(REPEAT ONE)

16) [SCAN] Button

Radio/TV : Press this button to scan the strong signaled stations/channels. When it reaches to the strong signaled stations/channels, the station/channel will be on for 5 seconds.

CD : Press this button to play the first 10 seconds of each track of CD disc. This function is not available on DVD/MP3 mode.

17) [SLOW] Button

Press this button to play the DVD disc at a slow speed as the following sequence.

1/2 -> 1/4 -> 1/8 -> 1/16 -> Normal -> Backward 1/2 -> 1/4 -> 1/8 -> 1/16

18) [DISP] Button

Press this button to change time display modes during playback. Whenever it is pressed, the time display changes as below.

DVD : TOTAL_ELAPSE (Total Elapsed) -> TITLE_REMAIN (Title Remain) -> CHAP_ELAPSE (Chapter Elapsed) -> CHAP_MAIN (Chapter Remain) -> Display Off

VCD/CD : SINGLE_ELAPSE (Single Elapsed) -> SINGLE_REMAIN (Single Remain) -> TOTAL_ELAPSE (Total Elapsed) -> TOTAL_REMAIN (Total Remain) -> Display Off

This function is not available on MP3 mode.

19) [TITLE] Button

Press this button to go to title menu of the DVD disc. This function is available only when the function is supported from DVD disc. Press [RETURN] button to return to the playback.

Radio : Press this button to enable or disable the AF feature.

20) [SUB T] Button

DVD : Press this button to change the subtitle of the DVD Disc.

This function is available only when DVD disc has the subtitle.

Radio :

-Short press : To enable or disable the TA feature. For any other mode, press it more than 1 sec. to enable or disable the TA feature.

21) [ANGLE] Button

Press this button to change the viewing angle during DVD video playback. This function is available only when DVD has the different angles.

Radio : Press this button to enable or disable the REG feature.

22) [AUDIO] Button

Press this button to change the audio output of the DVD disc during playback.

This function is available only when DVD disc has this feature.

Radio : Press this button to enable or disable the REG feature.

[Note]

The AF, TA, REG, and PTY features are available for RDS supported models only.

23) [MENU] Button

Short press : To go to the root menu during DVD playback.

Long press : To go to the title menu during DVD playback.

The function is available only when DVD disc has this feature.

24) [NAVI] Button (NAVIGATION-OPTION)

The functions are the same as the [NAVI] button on the main unit.

[Cautions] About the handling the remote control,

Incorrect use of batteries may cause explosion.

When replacing batteries, be sure to replace both of them with new ones.

Do not heat up batteries or take them apart.

Do not expose batteries to fire or flames.

Remove the batteries from the remote control when not in use for a long period time.

Do not take batteries apart and throw them at persons or animals.

Dispose of used batteries properly.

4. Basic Operations

■ Power on/off

[Cautions] - About using this unit

Use this unit while the engine is running. Using it with the engine off could lead to vehicle battery discharge and prevent the vehicle from being started. When you start the engine, the unit will return to the last settings before the engine was stopped.

Power On : Press the [POWER/SOURCE] button or touch LCD screen to turn the unit on. The unit will be powered on with the last settings.

[Note] - About the Last Memory playback of disc

If you power off the unit with DVD playback and then power it on, the unit will automatically play from where it powered off.

Power off : Press the [POWER/SOURCE] button more than 1 sec to turn the power off.

[Note] - About the illumination at night driving

The button lighting remain lit if illumination wire is connected correctly.

■ Source Selection

Press the [POWER/SOURCE] button to change sources. The source will be changed in the following sequence.

RADIO→TV→DVD→(NAVI)→EXTERN→(BLUETOOTH)

TV Source is indicated only on TV tuner built-in models.

NAVI mode is indicated only when "NAVI ON" is selected on SETUP-ETC-EXTERN-EXT MODE. (This function is limited only to the Navigation built-in model or external Navigation system is connected to this unit.)

BLUETOOTH mode is indicated only on Bluetooth built-in model.

[Note] - About the Source Selection using Icon of LCD Screen

When you touch the source icon at left upper side on LCD screen, the source selection board will be displayed. Touch the desired source to go to the desired source.

■ Volume Adjustment

- Press the (∧) button or touch the volume icon '+' on LCD screen to increase the volume.
- Press the (∨) button or touch the volume icon '-' on LCD screen to decrease the volume.

[Note] - About the protection of excessive volume output

If you set the volume level (10 level at factory) on setup menu **MAXIMUM VOLUME** of **SETUP-MAIN-BEEP/VOLUME**, the volume is automatically adjusted to the set volume level, when you turn the power on

[WARNING] - About the volume control for safety driving

Adjust the volume so that you can hear the sound from outside when the windows are closed.

■ Muting the Sound

Press [MUTE] button to mute the sound, the sound will be muted and the speaker icon on the screen changes to MUTE icon.

Press it one more time or adjust the volume to listen to the sound.

[Note] - About when this unit does not sound.

Check out if you mute the sound when this unit does not sound, but the picture works.

■ Adjusting the LCD Panel Angle

Short Press : To tilt the LCD Panel with one step up/down.

Long press : To tilt the LCD Panel continuously up/down while the button is pressed.

When you turn off the ignition, LCD panel closes automatically. When you start your car, the angle moves to the finally adjusted angle automatically. When you turn off the power using [POWER/SOURCE] button, LCD panel does not close.



[WARNING] - LCD panel handling,

Do not move or press LCD panel forcefully. This unit can be damaged or malfunctioned.

■ Inserting/Ejecting Disc

Press the [EJECT] button to insert the disc. The LCD panel will open and you can insert disc into the slot on the backside of LCD panel.

Push discs in the arrow direction to insert them.

Press the [EJECT] button to eject the inserted disc with LCD panel going down.

Pull the disc out, using the hand, and press the [EJECT] button once again to move the LCD panel to the finally adjusted angle.

For Navigation built-in model, use [TILT] button to tilt down LCD panel, and then, remove or insert the map memory into the slot of the backside of the LCD panel.

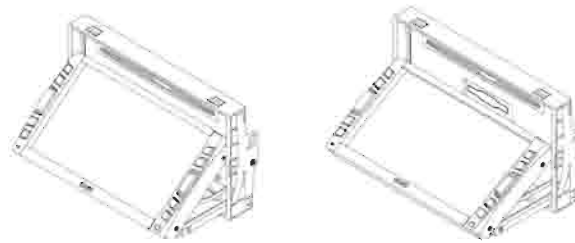

[Note] - About the protection of the disc,
When disc is ejected out, LCD panel cannot move when [EJECT] or [TILT] button is pressed.

[Note] - About the angle of LCD panel,
LCD panel will not move even when [EJECT] button is pressed, when LCD panel angle is downward more by pressing [TILT] button than by pressing [EJECT] button. Only the disc will be ejected. LCD panel does not move to the eject angle even when [EJECT] button is pressed after removing the disc.

■ Switch on/off LCD Monitor

Press [SETUP] button more than 1 sec. to turn off LCD monitor.

Press [SETUP] button shortly or touch LCD monitor when the monitor is off to turn the LCD monitor on again.

■ Using the Touch Screen

Touch the icon on the screen to activate the function.

If the icons are not displayed, touch the LCD screen to display the icons.

■ Exchanging the Remote Control Battery

- 1) Open the battery cover of the remote control by sliding it in the direction of the arrow.
- 2) Install 2 AAA(AM4 1.5V) batteries.
- 3) Close the cover.

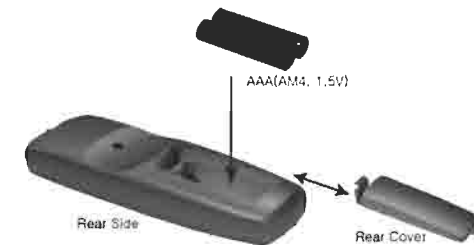

5. Operating Basic Functions

■ Radio Functions

1) Radio source Selection

Press [POWER/SOURCE] button on the main unit or source icon on the LCD screen to select RADIO source.

When you press the BAND button on the main unit, the BAND/DISC button on the remote control, or the BAND icon on the LCD panel, the frequency band will be changed. : FM1→FM2→FM3→AM1(MW)→ AM2(MW)

2) User Interface for Radio Source

Touch LCD monitor on Radio source, to display the icons that control Radio function. The icons will disappear not to bother watching it after 5 seconds.

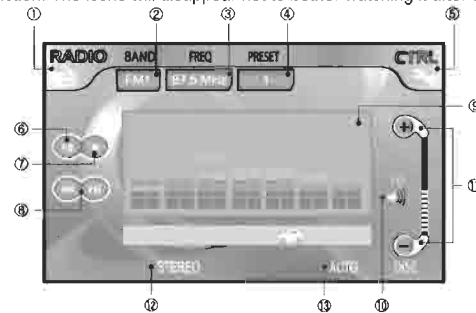

- ① Displays the active source. Press the icon to switch to the next source.
- ② Displays the active frequency band. Press the icon to change frequency bands. : FM1, FM2, FM3, AM1(MW), AM2(MW).
- ③ Displays the active station frequency. Press the icon to display the frequency selection board.
- ④ Displays the preset number if stations are memorized to the preset stations. Each time you press the icon, you will move to the next preset station.
- ⑤ Press to display the radio setup screen.
- ⑥ Press to scan strong signaled stations and to memorize in preset stations automatically. After preset memorization is completed, the preset stations will be on for 5 seconds for each station. Press it once again to stop the scanning when it reaches to your desired station.
- ⑦ Press to stop the scan or preset scan.
- ⑧ Press to seek to the previous/next stations.
- ⑨ The current sound condition is displayed in graphic EQ.
- ⑩ Press this icon to mute the sound. Press it once again to listen to the sound.
- ⑪ Adjust the audio volume. Increase or decrease the volume, by pressing (+), (-) icons.

- ⑫ The audio condition (STEREO) of current station is displayed.
- ⑬ SEEK MODE is displayed. (AUTO/MANUAL)

3) Radio Frequency Setup

Press the [SEEK] button to select the desired frequency.

Press [1] - [6] buttons on the remote control, in case that preset stations are memorized.

Press [FREQ] icon on the screen or [DIRECT] button on the remote control to display the frequency selection board.

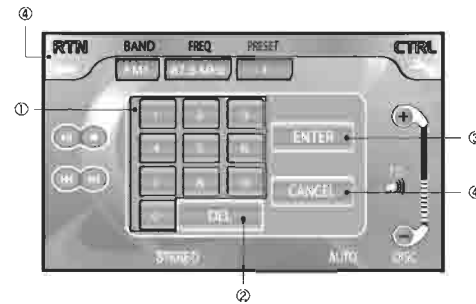

- ① Press to select the numbers on the screen or the numbers on the remote control for the desired frequency.
- ② Delete the selected numbers.

- ③ Press to go to the selected frequency.
- ④ Press to return to the previous screen without the frequency setup.

[Note] - When the selected frequency exceeds broadcasting band
In this case, the frequency does not move to the selected frequency, it will remain at the same frequency. (The frequency band of FM is 87.5 MHz - 108 MHz.)

4) Radio Control Setup

Press [CTRL] icon on Radio Source.

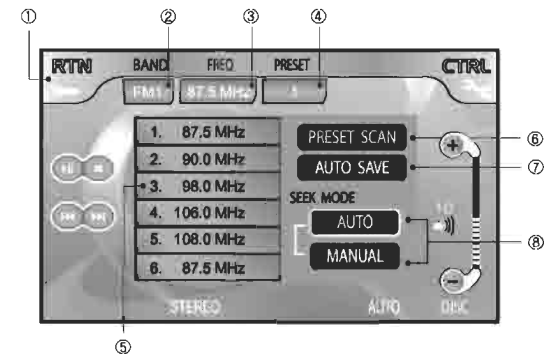

- ① Press to return to the previous screen.
- ② Press to change the band : FM1->FM2->FM3->AM1-AM2.

- ③ Press to display frequency selection board.
- ④ Press to change the preset station number.
- ⑤ It is a window to display the preset memorized stations, after the preset scanned. Press the icon of each preset station to move to the preset station directly. In order to memorize a desired frequency manually, put the desired frequency into the frequency selection board directly, or press [SEEK] button or to move to the desired frequency and then, press the preset number for memorization until it 'beeps'.
- ⑥ Press to scan all preset stations which were memorized in preset stations. The preset stations will be on for 5 seconds for each station. Press it once again to stop the scanning when it reaches to your desired station.
- ⑦ Press to scan all strong signaled stations and to memorize in preset stations automatically. After preset memorization is completed, the preset stations will be on for 5 seconds for each station. Press it once again to stop the scanning when it reaches to your desired station.

[Note] - Memorized Preset Broadcasting

The best strong stations will be memorized in the preset stations. In case that there are many poor receiving sensitivity, the stations memorized in the preset can be less than 6.

- ⑧ Press to change the Search method automatic or manual.

AUTO : Press SEEK button or seek icon to seek the radio frequency automatically, and it will go to the previous/next station.

MANUAL : Press SEEK button or seek icon to seek the radio frequency manually and it will move step by step.

5) Radio Preset Setup

Long Press : Press [PLAY/PAUSE] button on the main unit or [PLAY/PAUSE] icon on the LCD screen, the strong signaled stations will be searched and memorized in the preset stations and the preset scan will start.

Short Press : Press [PLAY/PAUSE] button on the main unit or [PLAY/PAUSE] icon on the LCD screen, the preset scan will start.

■ TV Functions

1) TV Source Selection

Press [POWER/SOURCE] button on the main unit or source icon on the LCD screen to select TV source.

When you press the BAND button on the main unit, the BAND/DISC button on the remote control, or the BAND icon on the LCD panel, the band will be changed. : TV1->TV2

2) User Interface for TV Source

Touch LCD monitor on TV source, to display the icons that control TV function.

The icons will disappear not to bother watching it after 5 seconds.

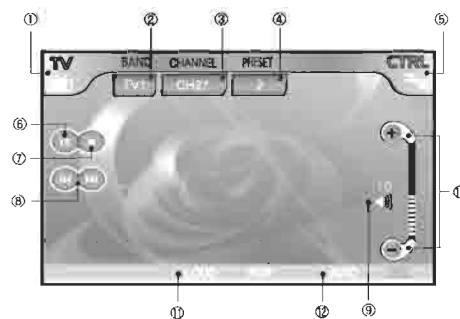

- ① Displays the active source. Press the icon to switch to the next source.
- ② Displays the active band. Press the icon to change bands. : TV1, TV2.
- ③ Displays the active channel. Press to display the channel selection board.
- ④ Displays the preset number if channels are memorized to the preset channels. Each time you press the icon, you will move to the next preset channel.
- ⑤ Press to display the TV setup screen.
- ⑥ Press to scan strong signaled channels and to memorize in preset channels automatically. After preset memorization is completed, the preset channels will be on for 5 seconds for each channel. Press it once again to stop the scanning when it reaches to your desired channel.
- ⑦ Press to stop the scan or preset scan.
- ⑧ Press to seek to the previous/next channels.
- ⑨ Press this icon to mute the sound. Press it once again to listen to the sound.
- ⑩ Adjust the audio volume. Increase or decrease the volume, by pressing (+), (-) icons.
- ⑪ The audio condition of present channel is displayed
- ⑫ SEEK MODE is displayed. (AUTO/MANUAL)

3) TV Channel Setup

Press the [SEEK] button to select the desired channel.

Press [1] - [6] buttons on the remote control, in case that preset channels are memorized.

Press [CHANNEL] icon on the screen or [DIRECT] button on the remote control to display the channel selection board.

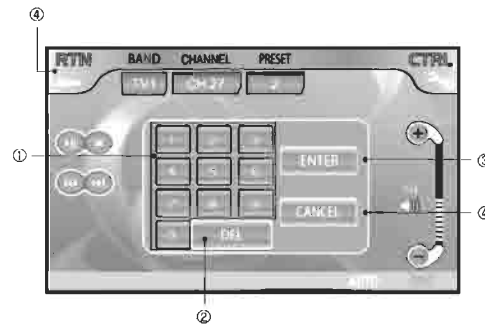

- ① Press to select the numbers on the screen or the numbers on the remote control for the desired channel.
- ② Delete the selected numbers.
- ③ Press to go the selected channel.
- ④ Press to return to the previous screen without the frequency setup.

[Note] - When the selected channel exceeds broadcasting band
In this case, the channel does not move to the selected channel, it will remain at the same channel. (The channel range of TV is CH02 – CH69.)

4) TV Control Setup

Press [CTRL] icon on TV Source.

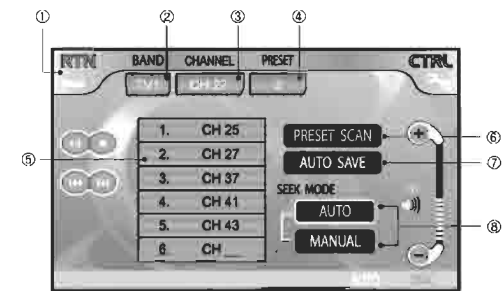

- ① Press to return to the previous screen.
- ② Press to change the band : TV1->TV2
- ③ Press to display channel selection board.
- ④ Press to change the preset channel number.

⑤ It is a window to display the preset memorized channels, after the preset scanned. Press the icon of each preset channel to move to the preset channel directly. In order to memorize a desired frequency manually, put the desired channel into the channel selection board directly, or press [SEEK] button or to move to the desired channel and then, press the preset number for memorization until it 'beeps'.

⑥ Press to scan all preset channels which were memorized in preset channels. The preset channels will be on for 5 seconds for each channel. Press it once again to stop the scanning when it reaches to your desired channel.

⑦ Press to scan strong signaled channels and to memorize in preset channels automatically. After preset memorization is completed, the preset channels will be on for 5 seconds for each channel. Press it once again to stop the scanning when it reaches to your desired channel.

[Note] - Memorized Preset Broadcasting

The best strong channels will be memorized in the preset channels. In case that there are many poor receiving sensitivity, the channels memorized in the preset can be less than 6.

⑧ Press to change the Search method automatic or manual.

AUTO : Press SEEK button or seek icon to seek the TV channel automatically, and it will go to the previous/next channel.

MANUAL : Press SEEK button or seek icon to seek the TV channel manually and it will move step by step.

5) TV Preset Setup

Long Press : Press [PLAY/PAUSE] button on the main unit or [PLAY/PAUSE] icon on the LCD screen, the strong signaled channels will be searched and memorized in the preset channels and the preset scan will start.

Short Press : Press [PLAY/PAUSE] button on the main unit or [PLAY/PAUSE] icon on the LCD screen, the preset scan will start.

■ Disc Playback Functions

1) Disc Source Selection

Press [POWER/SOURCE] button on the main unit or source icon on the LCD screen to select DVD. When DVD is selected, if a DVD disc already in the unit, the disc playback will start automatically. The icon will be changed DVD VIDEO, CD, MP3, VCD according to playing disc. If you insert a disc when the source is not DVD, the source will be changed to DVD source automatically, and the screen will be displayed according to discs.

2) DVD Video playback

● User Interface for DVD playback

On DVD playback, touch the LCD screen to display the User interface to control the DVD playback.

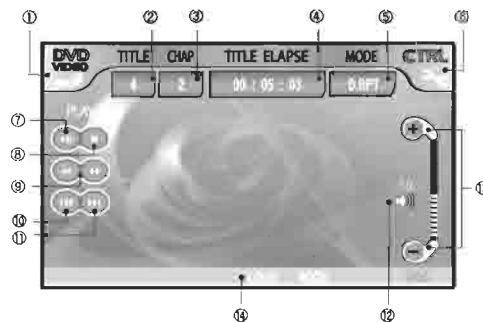

- ① Displays the active source. Press the icon to switch to the other source.
- ② Displays the number of the title that is being played. Press the icon to display the title selection board. And the "TITLE" icon will be changed to a number which will show how many titles this disc has. So, you will select the desired title number and press ENTER icon.
- ③ Displays the number of the chapter that is being played. Press the icon to display the chapter selection board. And the "CHAP" icon will be changed to a number which will show how many chapters this title has. So, you will select the desired chapter number and press ENTER icon.
- ④ Displays the playback time information. Press the icon to display the time selection board. And the playback time mode will be changed to a number which will show the total playback time. So, you will select the desired time where you will resume the playback.

Long Press : To change playback time information mode : TITLE_ELAPSE
→TITLE_REMAIN → CHAP_ELAPSE → CHAP_REMAIN.

TITLE - ELAPSE : shows title elapsed time

TITLE - REMAIN : shows title remaining time

CHAP - ELAPSE : shows chapter elapsed time

CHAP - REMAIN: shows chapter remaining time

⑤ Displays the disc playback mode. Press the icon to change playback mode.

D.RPT : repeat plays all the titles in the disc

RDM : plays all the chapters in the disc randomly.

NOR : plays normally.

RPT : repeat plays the chapter or the title that is being played.

⑥ Press to display DVD control setup screen.

⑦ Press to pause playback and press it once again to resume the playback.

⑧ Press to stop playing. Press [PLAY/PAUSE] icon to resume the playback from the stopped time. If you press [STOP] icon 2 times and press this icon [PLAY/PAUSE] icon, it will start from the beginning.

⑨ Press these buttons during DVD playback for high-speed playback.

>> Button : FF2X → FF4X → FF8X → FF32X → NORMAL SPEED

<< Button : FR2X → FR4X → FR8X → FR32X → NORMAL SPEED

⑩ Press to go to the previous chapter.

⑪ Press to go to the next chapter.

⑫ Press this icon to mute the sound. Press it once again to listen to the sound.

⑬ Adjust the audio volume. Increase or decrease the volume, by pressing (+), (-) icons.

⑭ The present audio condition is displayed.

● Title, Chapter, Time Setup

Press [TITLE], [CHAP], or [TIME] to display the selection board on DVD playback.

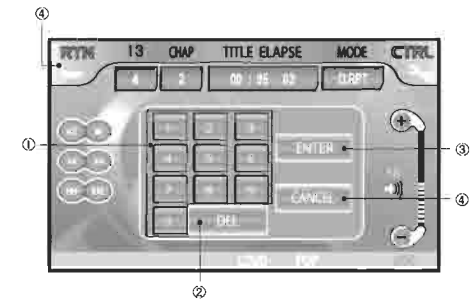

① Press the desired number for TITLE, CHAPTER, or Time direct function.

② Press to delete the selected number.

③ Press to go to the selected number.

④ Press to cancel the selected number.

[Note] - TITLE, CHAPTER, or TIME not found

If TITLE, CHAPTER, or TIME not found when you press the non-existing TITLE, CHAPTER, TIME, the playback remains unchanged.

● **Control Setup**

Press [CTRL] icon to setup the control the following screen on DVD source.

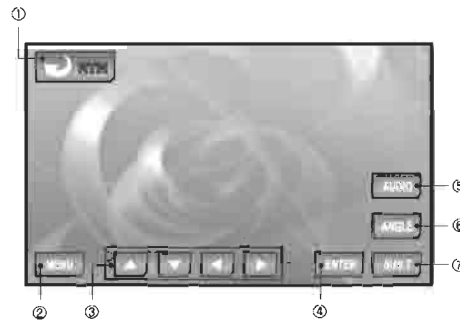

- ① Press to return to the previous screen.
- ② Press to go to the root menu of the DVD disc.
- ③ Press to move the cursor position.
- ④ Press to active the selected item.
- ⑤ Press this button to change the audio output of the DVD disc during playback. This function is available only when DVD disc has this feature.
- ⑥ Press this button to change the viewing angle of the DVD disc during playback. This function is available only when DVD disc has this feature.

- ⑦ Press this button to change the sub title of the DVD disc during playback. This function is available only when DVD disc has this feature.

[Note] - About Root Menu

The root Menu is different according to DVD disc and version. Use the direction buttons and [ENTER] button to view or change items as needed.

3) Audio CD playback

● **User Interface for Audio CD Playback**

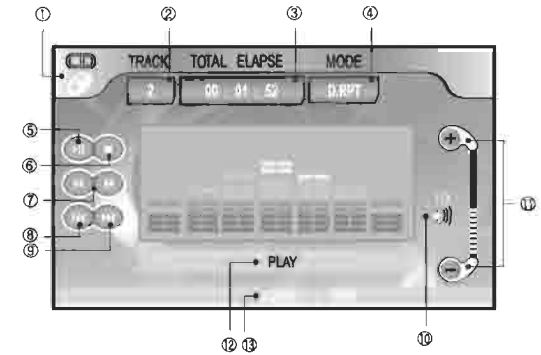

On Audio CD playback, touch the LCD screen to display the User interface to control the CD playback.

- ① Displays the active source. Press the icon to switch to the other source.

② Displays the number of the track that is being played. Press the icon to display the track selection board. And the "TRACK" icon will be changed to a number which will show how many tracks this disc has. So, you will select the desired track number and press ENTER icon.

③ Displays the playback time information. Press the icon to display the time selection board. And the mode will be changed to a number which will show the total playback time. So, you will select the desired time where you will resume the playback.

Long Press : To change playback time information mode : TOTAL_ELAPSE
→TOTAL_REMAIN → SINGLE_ELAPSE → SINGLE_REMAIN

TOTAL_ELAPSE : shows elapsed time of the disc

TOTAL_REMAIN : shows remaining time of the disc

SINGLE_ELAPSE : shows elapsed time of the song

SINGLE_REMAIN: shows remaining time of the song

④ Displays the disc playback mode. Press the icon to change playback mode.

D.RPT : repeat plays all the songs in the disc.

RDM : plays all the songs in the disc randomly.

NOR : plays normally.

RPT : repeat plays the song that is being played.

⑤ Press to pause playback and press it once again to resume the playback.

⑥ Press to stop playing. Press [PLAY/PAUSE] icon to resume the playback from the stopped time. If you press [STOP] icon 2 times and press this icon [PLAY/PAUSE] icon, it will start from the beginning.

⑦ Press these buttons during playback for high-speed playback.

>> Button : FF2X → FF4X → FF8X → FF32X → NORMAL SPEED

<< Button : FR2X → FR4X → FR8X → FR32X → NORMAL SPEED

⑧ Press to go to the previous track. If the elapsed time is over 5 seconds, the playing song will start from the beginning. If the elapsed time is not over 5 seconds, the previous song will start.

⑨ Press to go to the next song.

⑩ Press this icon to mute the sound. Press it once again to listen to the sound.

⑪ Adjust the audio volume. Increase or decrease the volume, by pressing (+), (-) icons.

⑫ The playback mode is displayed.

⑬ The present audio condition is displayed.

● **Track, Time Setup**

Press [TRACK], or [TIME] to display the selection board on CD playback.

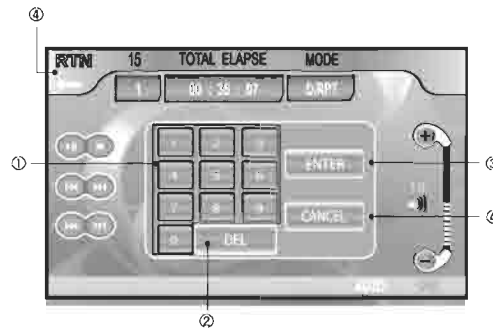

- ① Press the desired number for TRACK, or Time direct goto function.
- ② Press to delete the selected number.
- ③ Press to go to the selected number.
- ④ Press to cancel the selected number.

[Note] – TRACK, or TIME not found

If TRACK, or TIME not found when you press the non-existing TRACK, TIME, the playback remains unchanged.

4) MP3 playback

● **User Interface for MP3 Playback**

On MP3 playback, touch the LCD screen to display the User interface to control the MP3 playback.

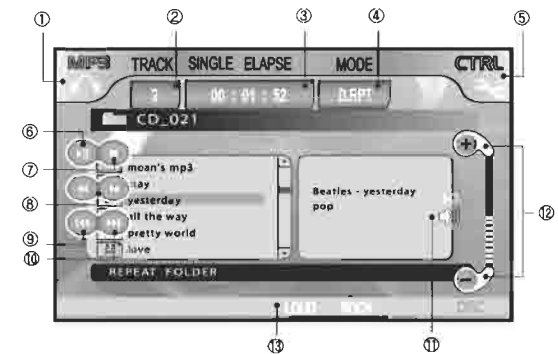

- ① Displays the active source. Press the icon to switch to the other source.
- ② Displays the number of the track that is being played. Press the icon to display the track selection board. And the "TRACK" icon will be changed to a number which will show how many tracks this disc has. So, you will select the desired track number and press ENTER icon.
- ③ Displays the playback time information. Press the icon to display the time selection board. And the mode will be changed to a number which will show

the total playback time. So, you will select the desired time where you will resume the playback.

④ Displays the disc playback mode. Press the icon to change playback mode.

F.RPT : repeat plays all the tracks in the disc

RDM : plays all the tracks in the disc randomly.

NOR : plays normally.

RPT : repeat plays the track that is being played.

⑤ Press to display MP3 control setup screen.

⑥ Press to pause playback and press it once again to resume the playback.

⑦ Press to stop playing. Press [PLAY/PAUSE] icon to start from the beginning.

⑧ Press these buttons during MP3 playback for high-speed playback.

>> Button : FF2X → FF4X → FF8X → FF32X → NORMAL SPEED

<< Button : FR2X → FR4X → FR8X → FR32X → NORMAL SPEED

⑨ Press to go to the previous track. If the elapsed time is over 5 seconds, the playing song will start from the beginning. If the elapsed time is not over 5 seconds, the previous song will start.

⑩ Press to go to the next track.

⑪ Press this icon to mute the sound. Press it once again to listen to the sound.

⑫ Adjust the audio volume. Increase or decrease the volume, by pressing (+), (-) icons.

⑬ The present audio condition is displayed.

● TRACK, Time Setup

Press [TRACK], or [TIME] to display the selection board on MP3 playback.

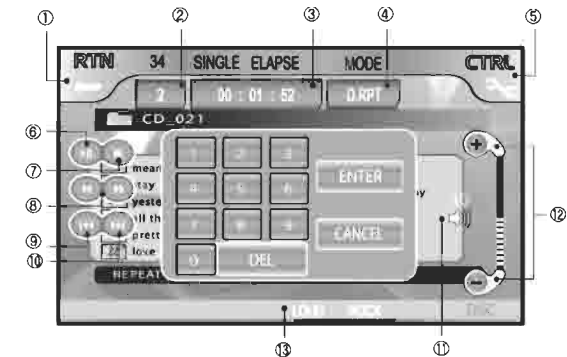

① Press the desired number for TRACK, or Time direct goto function.

② Press to delete the selected number.

③ Press to go to the selected number.

④ Press to cancel the selected number.

[Note] - TRACK, or TIME not found

If TRACK, or TIME not found when you press the non-existing TRACK, TIME, the playback remains unchanged.

● **Control Setup**

Press [CTRL] icon to setup the control the following screen on MP3 playback.



- ① Press to return to the previous screen.
- ② The playing song is indicated with Blue color cursor.

The selected song is indicated with yellow color cursor. After selecting the desired song, press ENTER icon to play the selected song within 10 seconds. If not, the selected song yellow cursor will disappear.

- ③ Press to move the cursor position up and down.
- ④ Press to move the cursor to the previous/next page.
- ⑤ Press to play the selected song.

5) Video CD playback

● User Interface for VCD Playback

On VCD playback, touch the LCD screen to display the User interface to control the VCD playback.

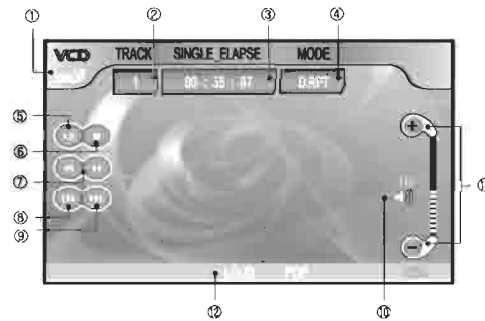

- ① Displays the active source. Press the icon to switch to the other source.
- ② Displays the number of the track that is being played. Press the icon to display the track selection board. And the "TRACK" icon will be changed to a number which will show how many tracks this disc has. So, you will select the desired track number and press ENTER icon.
- ③ Displays the playback time information. Press the icon to display the time selection board. And the playback time mode will be changed to a number

which will show the total playback time. So, you will select the desired time where you will resume the playback.

Long Press : To change playback time information mode : TOTAL_ELAPSE → TOTAL_REMAIN → SINGLE_ELAPSE → SINGLE_REMAIN.

TOTAL_ELAPSE : shows disc's elapsed time

TOTAL_REMAIN : shows disc's remaining time

SINGLE_ELAPSE : shows the current track's elapsed time

SINGLE_REMAIN : shows the current track's remaining time

- ④ Displays the disc playback mode. Press the icon to change playback mode.

D.RPT : repeat plays all the tracks in the disc

RDM : plays all the tracks in the disc randomly.

NOR : plays normally.

RPT : repeat plays the track that is being played.

- ⑤ Press to pause playback and press it once again to resume the playback.
- ⑥ Press to stop playing. Press [PLAY/PAUSE] icon to resume the playback from the stopped time. If you press [STOP] icon 2 times and press this icon [PLAY/PAUSE] icon, it will start from the beginning.
- ⑦ Press these buttons during VCD playback for high-speed playback.
>> Button : FF2X → FF4X → FF8X → FF32X → NORMAL SPEED
<< Button : FR2X → FR4X → FR8X → FR32X → NORMAL SPEED

- ⑧ Press to go to the previous track. If the elapsed time is over 5 seconds, the playing song will start from the beginning. If the elapsed time is not over 5 seconds, the previous song will start.
- ⑨ Press to go to the next track.
- ⑩ Press this icon to mute the sound. Press it once again to listen to the sound.
- ⑪ Adjust the audio volume. Increase or decrease the volume, by pressing (+), (-) icons.
- ⑫ The present audio condition is displayed

- ① Press the desired number for TRACK, or Time direct goto function.
- ② Press to delete the selected number.
- ③ Press to go to the selected number.
- ④ Press to cancel the selected number.

[Note] - TRACK, or TIME not found

If TRACK, or TIME not found when you press the non-existing TRACK, TIME, the playback remains unchanged.

● **Track, Time Setup**

Press [TRACK] or [TIME] to display the selection board on VCD playback.

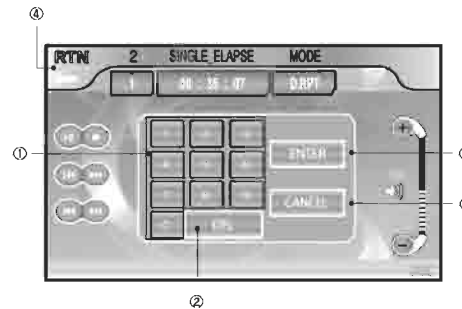

■ Navigation System (OPTION)

This function is only limited to the navigation built-in models and external navigation system. When the external navigation system is connected to this model through RGB, the navigation operation is controlled by touch screen.

1) Navigation source Selection

Set the SETUP-ETC-EXTERN-EXT3 Mode to "NAVI ON", NAVI source will be available on source selection board on the screen. Press [POWER/SOURCE] button or Source icon to select NAVI.

2) User Interface for Navigation Source

Press the source changing icon area while operating Navigation to display user interface. The user interface will disappear after 2 seconds.

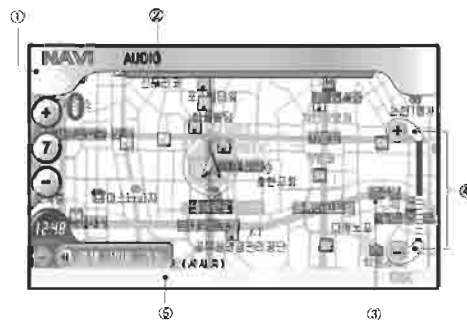

- ① Displays the active source. Press the icon to switch to the other source.
- ② Displays the active Audio Source. You can listen to the desired source while watching Navigation map. Press the source icon to change the audio source as : Radio->TV->DVD->NAVI->EXT->(BT).
- ③ Press this icon to mute the sound. Press it once again to listen to the sound.
- ④ Adjust the audio volume. Increase or decrease the volume, by pressing (+), (-) icons.
- ⑤ The present audio condition is displayed.

[Note] - About External Navigation through RGB Connection

In order to connect the navigation system to this unit, the External navigation system should have 13PIN RGB connector. For navigation video output, you should adjust the SETUP-ETC-EXTERN -EXT3 MODE to "NAVI ON" according to your navigation system. In this case, the Navigation voice can be heard through the speaker and the navigation operation can be done by Touch-Screen.

■ External Functions

1) External source Selection

Press [POWER/SOURCE] button or Source icon to select EXTERN.

2) User Interface for External source

The user interface for EXTERN source will be displayed as the following picture.

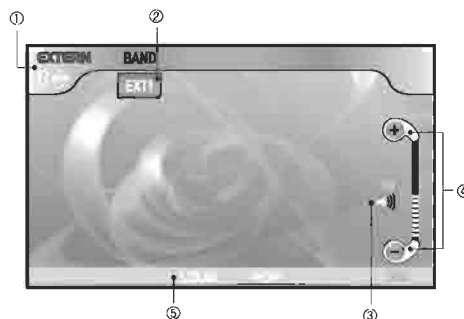

- ① Displays the active source. Press the icon to switch to the other source.
- ② Displays the active EXTERN Source. Press the EXT icon to change the EXTERN source as : EXT1->EXT2(CAM)->EXT3.

-EXT1 : Displays the AV Input source connected to AV Input cable.

-EXT2 : Displays the Video source connected to REAR CAM IN(Video, NO audio). When you connect rear view camera to this unit, you should set SETUP-ETC-EXTERN-EXT2 mode to "REAR CAM ON" and it will display "CAM" instead of "EXT2". And if it receives the Rear camera video source to this unit, it will detect the video source and will change to "EXT2(CAM)" source and will show the Rear Camera Video source automatically on any mode.

-EXT3 : Displays the Video source connected to RGB input or CVBS Video & Mono Audio through 13 PIN Navigation cable.

[Note] : REAR CAMERA VIDEO SOURCE AUTO DETECTING
If you connect the Rear camera video source to this unit, it will detect the video source automatically. This unit does not have the Rear View Wire. The only thing you should do to watch the rear camera video is to connect the video source cable to "REAR CAMERA IN" cable of this unit.

- ③ Press this icon to mute the sound. Press it once again to listen to the sound.
- ④ Adjust the audio volume. Increase or decrease the volume, by pressing (+), (-) icons.
- ⑤ The present audio condition is displayed.

■ Bluetooth Functions (OPTION)

This function is available which has Bluetooth handsfree built-in models.

You can control the handsfree mode and MP3 player function of the bluetooth mobile phone on Bluetooth source. The function will be active only after the pairing with mobile phone is done.

[Note] : About Controlling the MP3 Function of Bluetooth Phone

The function is available only to mobile phones which has Bluetooth Stereo Headset and MP3 player function.

1) Bluetooth source Selection

Press [POWER/SOURCE] button or Source icon to select Bluetooth at the source selection board.

2) User Interface for Bluetooth Source

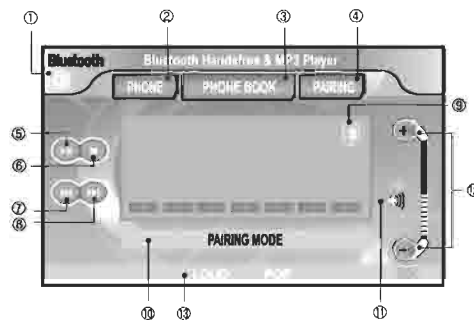

- ① Displays the active source. Press the icon so to switch to the other source.
- ② Press to display the phone no. selection board to make a phone call.
- ③ Press to display the memorized phone book list to make a phone call directly. 10(0~9) telephone no. can be memorized in the list.
- ④ Press to pair this unit with the bluetooth mobile phone.
- ⑤ Press to play/pause the MP3 song of the bluetooth mobile phone after pairing. This function is available for the bluetooth phone has MP3 player.
- ⑥ Press to stop MP3 playback.
- ⑦ Press to go to the previous MP3 file. If the elapsed time is over 5 seconds, the playing song will start from the beginning. If the elapsed time is not over 5 seconds, the previous song will start.
- ⑧ Press to go to the next MP3 file.
- ⑨ Displays the Bluetooth condition. If the color of Bluetooth is red, it is not paired to the mobile phone. If the color is white, it is paired.
- ⑩ Displays the present mode.

Handsfree Mode : Bluetooth handsfree mode

MP3 Player Mode : MP3 playback of Bluetooth Mobile phone.

Pairing Mode : Pairing mode of Bluetooth

- ⑪ Press this icon to mute the sound. Press it once again to listen to the sound.
- ⑫ Adjust the audio volume. Increase or decrease the volume, by pressing (+), (-) icons.
- ⑬ The present audio condition is displayed

3) Bluetooth Pairing Process

- ① Press the [PAIRING] icon to do the pairing.
- ② Start searching Bluetooth with your mobile phone, using "Other bluetooth Connection-Stereo Headset".
- ③ In case that your mobile phone find the bluetooth of this unit, "CAFEEL-650" will be displayed on your mobile phone. Select the "CAFEEL-650" from the found bluetooths and press enter to start the pairing. If your mobile phone is asking the password, press the password "0000" and press enter.
- ④ After the pairing, the color of Bluetooth icon on LCD screen will be changed to white. If it is not connected with the mobile phone, the color of Bluetooth icon is red.
- ⑤ Refer to the user's manual of your mobile phone for the detailed information for the pairing.

4) User Interface for Calling / Receiving Phone call

Press [PHONE] icon to display the Phone No. selection board or when telephone is ringing, the phone no. selection board will be displayed.

When you have a phone call, the Phone No. selection board will be displayed on any source to receive the call. The original source sound will be muted and the phone ringing will be heard through the left front speaker.

The microphone for phone talk is located at the left bottom side of the main unit.



- ① Press to return to the previous screen.
- ② Press the desired phone number. If you want to store the selected number into the phone book, press No 0 to 9 more than 1 sec. The telephone number

will be memorized into the phone book. Press the No. 0 to 9 more than 1 sec, it will call to the memorized phone no directly.

- ③ Press this number to call to the selected numbers. Press to receive the phone call. When you press [CALL] icon while talking on the phone, you can talk to the mobile phone for secret talking.
- ④ Press to hang up the phone.
- ⑤ Delete the selected numbers.

[Note] - When the phone rings during MP3 playback of the phone,
it will be changed to "HANDSFREE MODE" and the phone no. selection board will be displayed automatically, press the [CALL] button to receive the call. After the phone call, it returns to "MP3 PLAYER MODE", and it will resume the playback of the MP3.

5) User Interface for Calling with Phone book

Press [PHONE BOOK] icon to display the phone book selection board.

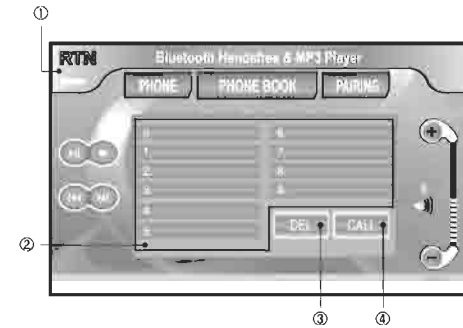

- ① Press to return to the previous screen.
- ② Press to select the desired phone no. to call.
- ③ Press to delete the phone number from the phone book list.
- ④ Press to call the selected phone number.

[Note] – Memorized Phone no. in the phone book,
The memorized phone numbers are different from the phone numbers memorized in your mobile phone.

6. Detailed Function Operations

■ Main Setup

Press [SETUP] button on the main unit to display the [SETUP] menu on the LCD screen.

Press [RTN] icon to finish the [SETUP] or the [SETUP] menu will disappear after 10 seconds if no buttons or icons are pressed.

1) Screen

Adjust CONTRAST, TINT, COLOR, BRIGHT on LCD as you want.



- CONTRAST : Press (+) / (-) icons to adjust contrast.

- TINT : Press (+) / (-) icons to adjust tint.

- COLOR : Press (+) / (-) icons to adjust color.

- BRIGHT : Press (+) / (-) icons to adjust brightness.

[Note] – To reset to the factory settings

Press the (DEFAULT) icon to reset to the factory settings.

2) Dimmer

Adjust the brightness of LCD screen according to the surrounding brightness.



Adjust the illumination of LCD screen by pressing (+) / (-) icon.

[Note] – To reset to the factory settings

Press the (DEFAULT) icon to reset to the factory settings.

3) Beep/Volume

Set up the beep sound and maximum volume.



- Beep sound : Press to turn on/off the beep sound which beeps when buttons or icons are pressed.

ON : To hear the beep sound.

OFF : To remove the beep sound.

- Maximum volume : To set up the maximum volume level when power is on. This function is for preventing the exceeding volume output when the unit is powered on. If the volume is exceeding the maximum volume level when turned off, the volume will be set to the maximum volume level when the unit is powered on again for the safety of the driver.

If the volume level is set to the non-exceeding level when powered off, the volume level when turning on again will be the same volume level.

[Danger] - Controlling Maximum Volume & Safety of Driver

When the volume is adjusted to the maximum, the volume output cause a careless driving. And it is harmful to the weak passengers, the pregnant passengers, and patients. Adjust the volume properly.

[Caution] - Controlling Maximum Volume for Safety Driving

For the safety driving, the volume should be adjusted to a level that the driver can listen to the sound coming from the outside of your car.

4) CLOCK SET UP

Set up the time display, 12H/24H setting, current time.



Time Display : Displays the current time at the bottom left side of the screen.

-ON : To display the current time on the screen.

-OFF : Not to display the current time on the screen.

You can set up 12 HRS time display or 24 HRS time display.

-12H : To display 12 Hour time on the screen. Morning and afternoon time are indicated by AM/PM. AM/PM displays only on 12Hour Time.

-24H : To display 24 Hour time on the screen.

Time Set : To change the current time.

-Hour/Minute : To change Hour/Minute by pressing (▲) / (▼) icons.

-AM/PM : Change them by pressing time display icon.

Press [SET] icon to save changed time.

[Note] - About Saving the Changed Time

You should press [SET] button after changing the time to save the changed time into this unit. If not, the previous time will be displayed.

5) LANGUAGE SETUP

Press to change the OSD language display on the screen.



OSD Language Setup : Select the desired language(ENGLISH, FRENCH, ITALIAN, SPANISH, RUSSIAN, GERMAN, CHINESE) and press [SET] icon to change it. After this, the unit will be reset for new language OSD display.

[Note] - About OSD Language

Only OSD language on the screen can be changed. The Disc language (MP3 file name, DVD language) cannot be changed.

■ Sound Setup

Press [SETUP] button on the main unit and press [SOUND] icon on the screen.
Press [RTN] icon to finish the [SETUP] or the [SETUP] menu will disappear after 10 seconds if no buttons or icons are pressed.

[Note] - About [NAVI VOICE] icon

[NAVI VOICE] icon is displayed only when you set up on SETUP - ETC - EXTERN - EXT3 mode to NAVI ON.

1) AUDIO CONTROL

To set up the volume of left/right/front/rear speakers and the sound effects.



Balance / FADER : Press the arrow icons to setup the Balance and Fader.

Loud : Press the LOUD ON/OFF icon to set to ON / OFF.

ON : To emphasize the sound at bass(100Hz) and loud(10KHz).

OFF : To set the sound to the basic sound.

[Note] - About LOUD effect

If the volume is too high, LOUD effect decreases.

When you set LOUD "ON", LOUD sign will be displayed on the bottom.

Bass Sound

ON : To emphasize the sound at bass(100Hz).

OFF : To set the sound to the basic sound.

[Note] - To reset to the factory settings

Press the (DEFAULT) icon to reset to the factory settings.

2) CENTER/WOOFER SETUP

To set up the center channel and woofer channel of 5.1 ch system.



Press the speaker icons to turn on/off the sound of each channel.

Center : Press (-)/(+) icons to increase/decrease Center volume.

Woofer : Press (-)/(+) icons to increase/decrease Woofer volume.

[Note] – To reset to the factory settings

Press the (DEFAULT) icon to reset to the factory settings.

3) EQ Select SETUP

To set up EQ(Equalizer). When the EQ is set up, the selected EQ will be displayed at the bottom of the screen.



The 3 basic EQ(POP, CLASSIC, ROCK) can be selected by pressing each icons and 3 user EQ mode can be selected.

POP : To select for pop genre music.

CLASSIC : To select for classic genre music.

ROCK : To select rock genre music.

USER 1/2/3 : To select the User set EQ(equalizer).

DEFEAT : Not to use EQ. EQ display at the bottom on screen will disappear.

4) My EQ SETUP

To set up the EQ of the User.



To set up the sound of BASS, MID, TREBLE. Each can be set up 15 grades (from -7 to +7).

-BASS(100Hz) : Press [BASS] icon and then adjust by pressing (▲)/(▼) icons.

-MID(1KHz) : Press [MID] icon and adjust by pressing (▲)/(▼) icons.

-TRE(10KHz) : Press [TRE] icon and adjust by pressing (▲)/(▼) icons.

After adjusting, press one of ①, ②, ③ icons of SAVE TO USER to save the adjusted EQ to the number.

[Note] - To use the user EQ

The adjusted and saved My EQ can be used "EQ SELECT".

5) SRC Offset SETUP

To setup the initial volume settings of each source(TV, CD, DVD, NAVI). Press [SRC OFFSET] icon to adjust.



You can adjust SRC OFFSET on the active source only. So, you can adjust the DVD SRC OFFSET when you play the DVD Title.

OFFSET setup can be adjusted up and down with 7 levels on the basis of the current volume level.

6) NAVI Voice (OPTION)

When you set SETUP - EXTERN - EXT3 MODE to "NAVI ON" and if this unit has the built in navigation system or connected to the External Navigation system through RGB connection, [NAVI VOICE] icon will be displayed as the following picture.



Voice NAVIGATION function : If you set the source to the other source when the unit is on Navigation, the video and audio will be changed according to the selected source. When an navigation announcement is on, the Audio of the active source will be muted, and after the announcement the Audio of the active source will be on.

ON : Voice NAVIGATION operates.

OFF : Voice NAVIGATION does not operate.

■ DVD Setup

Press [SETUP] button on the main unit and press [DVD] icon.

Press [RTN] icon to finish the [SETUP] or the [SETUP] menu will disappear after 10 seconds if no buttons or icons are pressed.

[Note] - About DVD Setup

DVD setup can be selected only when DVD source is active.

[Note] – To reset the DVD Setup to the factory settings

Press the [DEFAULT] icon to reset to the factory settings.

1) General Setup Page



[Note] – General Setup

Move the cursor using ▲ / ▼ / ◀ / ▶ icons on LCD Screen to select the desired menu and press [ENTER] icon to change the selected items.

● TV Display

Press the direction keys ▲ / ▼ / ◀ / ▶ to select TV Display. If TV Display is selected, press enter key and press the direction keys ▲ / ▼ to select the desired TV display and press enter key. And press the direction key ◀ to save the change.

- Normal/PS : Screen with Pan & Scan. Left end & Right end of the picture will be cut off slightly.
- Normal/LB : Screen with Letter Box
- Wide : 16 : 9 Screen

● Angle Mark

Press the direction keys ▲ / ▼ / ◀ / ▶ to select the Angle Mark. If Angle Mark is selected, press enter key to change it.

- ON : When selected, the Angle Mark will be shown on a specific scene which has angle function.
- OFF: When selected, no angle mark will be shown on the screen. This function is working on DVD Disc which has angle mark function on.

● OSD Lang(OSD LANGUAGE)

Press the direction keys ▲ / ▼ / ◀ / ▶ to select the OSD Lang. If OSD Lang is selected, press enter key to change English. Only English OSD menu is available for DVD SETUP.

[Note] – OSD MENU for DVD

This OSD menu is only for DVD SETSUP menu only, not the main unit.

● Captions

Press the direction keys ▲ / ▼ / ◀ / ▶ to select the Captions. If Captions is selected, press enter key to change ON or OFF. This function works with the VCD playback.

● Last memory

To save the last position of the DVD Title playback. Press the direction keys ▲ / ▼ / ◀ / ▶ to select the Last Memory. If Last Memory is selected, press enter key to change ON or OFF.

- ON : It memorizes the position at which the playback stopped. It resume the playback from the position it stopped.
- OFF : It doesn't memorize the position at which the playback stopped. It will start the playback from the beginning.

2) Audio Setup Page

● Speaker Set up

Press the direction keys ▲ / ▼ / ◀ / ▶ to select the Speaker Set up. If Speaker Set up is selected, press enter key to reach to Speaker Set up page as the following picture. Press enter key to select the desired items to change.



* Down Mix : If you do not have the 6CH speakers, you can change the Down Mix to according to the speakers.

- LT/RT : Left Total/Right Total. Multi-channel audio information is mixed.
- Stereo : Left Only/Right Only. Multi-channel audio information is in stereo.
- V Surr : Multi-channel audio information is in virtual surround.

*Front Speaker : Setup output of the front speaker.

- Large : Set the front speaker to produce a large output.
- Small : Set the front speaker to produce a small output

*Center Speaker : Setup output of the Center speaker.

- Large : set the center speaker to produce a large output.
- Small : Set the center speaker to produce a small output.
- Off : Select "Off" if you do not have the Center speaker

[Note] – Center Speaker

You can select the center speaker only if downmix is set to Off.

[Caution] – Center Speaker

If you set 5.1 channel without center speaker, be sure to set it to OFF. Otherwise, the voice(center channel) will not be heard.

*Rear Speaker : Setup output of the rear speaker.

- Large : Set the rear speaker to produce a large output.
- Small : Set the rear speaker to produce a small output
- Off : Select "Off" if you do not have the Rear speaker

*Subwoofer Speaker : Setup the output of the Subwoofer speaker

- On : Set the subwoofer to produce output.
- Off : Set the subwoofer to produce no output.

*Post DRC : Setup the Post DRC.

- On : When the volume is big at a specific point, it will make the volume bigger gradually and softly.
- Off : Post DRC is off.
- Auto : Auto Selection

● **SPDIF Set up**

This unit does not support SPDIF Audio Output. Do not change any settings at SPDIF Setup. If you change the settings at SPDIF, audio output for this unit can not be made. If you change any settings, press [DEFAULT] icon to reset to the factory settings.

● **Dolby Digital Setup**

* Dual Mono

Select in which way to output Dolby Digital audio as mono sound.

- STEREO : Select for stereo output
- L-Mono : Output only Left sound through Left/Right Speakers.
- R-Mono : Output only Right sound through Left/right Speakers.
- Mix-Mono : Combine and output the left & right sound through Left/Right Speakers.

* Dynamic (Dynamic Range Compression)

To setup the Dynamic Range of the Dolby Digital Audio. Dynamic Range is the difference between the highest level and the lowest level.

- Full : In order to limit the audio output at a specific level, adjust Dynamic at full. The volume level will not be over at a specific level, even if the audio output of DVD title is very high.
- OFF : In this Setting, the audio output is not limited.

● **Channel Delay**

Set delay time by channel according to the speaker type and location.

Press the direction keys ▲ / ▼ / ◀ / ▶ to select Channel Display. If Channel Display is selected, press enter key to select the speakers to be delayed.

The following shows the channel delay range of each speaker.

Center : 0cm ~ 170cm

Subwoofer speaker : 0cm ~ 510cm

Left surround : 0cm ~ 510cm

Right surround : 0cm ~ 510cm

● **Equalizer**

Set the 3D surround Equalizer sound during DVD Playback.

*EQ Type

Supported EQ Types are Rock, Pop, Live, Dance, Techno, Classic, & Soft.

*Boost

You can boost Bass, Super Bass, Treble to set "On".

● **3D processing**

Set the 3D Processing to enjoy the Reverb mode.

*Reverb Mode

Press the direction keys ▲ / ▼ / ◀ / ▶ to select Reverb Mode. If Reverb Mode is selected, press enter key to change Reverb Mode, Off → Concert → Living Room → Hall → Bathroom → Cave → Arena → Church. You can enjoy the Reverb(sound field) effects according to your taste.

● **HDCD**

Press the direction keys ▲ / ▼ / ◀ / ▶ to select HDCD. If HDCD is selected, press enter key to access HDCD Set up page. And press enter key to select Filter and press enter key to adjust Filter.

OFF → 44.1K → 88.2K

After adjusting Filter, press enter key and press the direction key ◀ to go to Audio Set up page, press the direction key ◀ once again and press the direction key ▶ to go to Video Set up Page.

3) Video Set Up Page



Press the direction keys ▲ / ▼ / ◀ / ▶ to select the Speaker Set up. If Speaker Set up is selected, press enter key to reach to Speaker Set up page as the following picture. Press enter key to select the desired items to change.

● **Component**

To set the Video output to the TFT LCD. Video Component of this unit is set to RGB.

● **TV Mode**

To set the display method. TV Mode of this unit is set to Interface.

● **Quality**

To set the quality of the Video signal of the DVD playback.

*Sharpness

Press the direction keys ▲ / ▼ / ◀ / ▶ to select Sharpness. If Sharpness is selected, press enter key to change Sharpness, High, Medium, Low. After selecting, press enter key to save the change.

*Brightness

Press the direction keys ▲ / ▼ / ◀ / ▶ to select Brightness. If Brightness is selected, press enter key to change Brightness, the following picture will be displayed. Press direction keys ◀ / ▶ to adjust the Brightness.



***Contrast**

Do the same process of Brightness to adjust Contrast.

***Gamma**

Press the direction keys ▲ / ▼ / ◀ / ▶ to select Gamma. If Gamma is selected, press enter key to change Gamma, High, Media, Low, None.

***Hue**

Do the same process of Brightness to adjust Hue.

***Saturation**

Do the same process of Brightness to adjust Saturation.

***Luma Delay**

Press the direction keys ▲ / ▼ / ◀ / ▶ to select Luma Delay. If Luma Delay is selected, press enter key to change Luma Delay, 0T, 1T. You can move the picture to the Left or to the Right slightly to adjust the position of the picture. After adjusting all the settings of Quality Set up, press the direction key ◀ to go to Video set up page, and then press the directions key ◀ once again and press the direction key ▶ to go to preference setup page.

4) Preference Page

● **TV Type**

Press the direction keys ▲ / ▼ / ◀ / ▶ to select TV Type. If TV Type is selected, press enter key to change the TV Type PAL, NTSC as following picture.

[Note] – Preference Setup Page

To get into the preference setup page, you must stop the DVD Playback.

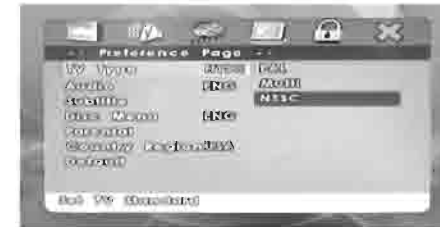

● **Audio(Soundtrack Language)**

To set the audio languages. The available languages are English, French, Spanish, Chinese, Japanese, Korean, Russian, Thai, Others. The languages are available only when the DVD title supports the selected language.

● **Subtitle**

To set the language of Subtitles. The available languages of Subtitle are English, French, Spanish, Chinese, Korean, Russian, Thai and Others. The languages are available only when the DVD title supports the selected language.

● **Disc Menu**

To set the language of Disc Menu. The available languages of Disc Menu are English, French, Spanish, Chinese, Korean, Russian, Thai and Others. The languages are available only when the DVD title supports the selected language.

● **Parental**

To limit the viewing by rating. the Parental Rates are 1 KID Safe, 2 G, 3 PG, 4 PG 13, 5 PGR, 6 R, 7 NC17, 8 ADULT.

[Note] – Parental Setup

This feature is only available when a password is setup.

● **Country Region**

Press the direction keys ▲ / ▼ / ◀ / ▶ to change Country Region : China, France, Hong Kong, Japan, Taiwan, GBR, USA .

● **Default**

Press the direction keys ▲ / ▼ / ◀ / ▶ to select Default. Press this icon to reset the unit to factory settings.

5) Password Set Up Page

● **Password Mode**

Press the direction keys ▲ / ▼ / ◀ / ▶ to select Password Mode. If Password Mode is selected, press enter key to select ON, OFF as following picture.



- On : To use the password. To select On and the password input window will be displayed to put the 4-digit password after putting the password, select OK and press enter key to save the change. You should remember the password for future usage. The Default setting password is 1234.

- Off : Not to use the password. Select Off and press enter key.

● **Password Change**

To change the password. You should put the old password and new password and new password once again to confirm the new password. And select OK and press enter key to save the change.

6) EXIT

After adjusting all the settings, press the direction key ◀ and press the direction key ▶ to select X icon and press enter key to go out from the Set up page.

■ ETC Setup

Press [SETUP] button on the main unit AND press [ETC] icon to display the [ETC] menu on the LCD screen.

1) TV Antenna Diversity

Adjust the DIVERSITY ANTENNA to ON, OFF.



- ON : The diversity antenna will automatically select the channel with the best reception out of four channels.
- OFF : Only the antenna connected to the Antenna no. 1 connector will be used.

[Note] – Diversity Antenna

This unit can connect the diversity antenna to four channels. If it is set to ON, the channel with the best reception will be automatically selected.

2) EXTERN Setup



*EXT2 MODE :

- Rear camera On : Set Rear camera an external input when you connected the rear camera to "REAR CAMERA IN" cable. "CAM" will be displayed on the EXTERN mode-EXT2.
- Rear camera Off : Set EXT2 Input as External input when you connected other external video source to rear camera input. "EXT2" will be displayed on the EXTERN mode-EXT2.
- Mirror On : Mirror-Look image of Rear camera(EXT2) video will be displayed.
- Mirror Off : Original image of Rear Camera(EXT2) video will be displayed.

*EXT3 MODE : Set NAVI ON, when you have the built in Navigation model or when you connected External Navigation system to this unit.

- NAVI ON : You can have the Navigation Mode on the Source Selection board and you will have External Input 1 and External Input 2 only.

- NAVI OFF : You can not select the Navigation Mode on the Source Selection board and you will have External Input1, External Input2 and External Input3.

**Built-Navigation System & Compatible navigation System connected:

Navigation Source can be selected and Navigation operation can be operated by touch screen.

**External Navigation System :

Navigation Source cannot be selected and Navigation operation cannot be operated by touch screen. EXT3 will be displayed as NAVI.

■ ZONE SETUP

Press [SETUP] button on the main unit and press [ZONE] icon.

Press [RTN] icon to finish the [SETUP] or the [SETUP] menu will disappear after 10 seconds if no buttons or icons are pressed.

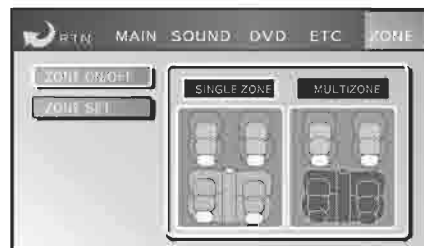

1) ZONE ON/OFF

-SINGLE ZONE : The active source will be displayed to the rear monitor through AV output.

-MULTI ZONE : The "Rear" source set in ZONE SET will be displayed to the rear monitor.

2) ZONE SET

-REAR SRC : To set the External AV Output source. You can select External AV Output source DVD, TV, Radio, EXT1, EXT2, EXT3.

[Note] : If you set ETC-EXTERN-EXT3 MODE to NAVI ON, the EXT3 will not be available for the external AV Output source.

-SPEAKER : To set the output for each speaker.



-SINGLE AUDIO : The audio output from Front and rear source will be the same.

FRONT SRC : The audio output from front source will be on from all speakers.
REAR SRC : The audio output from rear source will be on from all speakers.

-DUAL AUDIO : The audio output from front and rear source will be different.
FRONT/REAR : The audio output from front source will be on front speakers only. And the audio output from rear source will be on the rear speakers only.

■ Adjusting touch sensitivity of the LCD Panel

Severe temperature fluctuations or environmental changes could cause the panel's touch sensitivity to change, preventing the icons on the panel from working. In this case you can adjust the touch sensitivity of the LCD panel to optimize it.

How to adjust touch sensitivity

1) Press the [SETUP] button and then press the [NAVI] button more than 3 seconds to display the following screen.

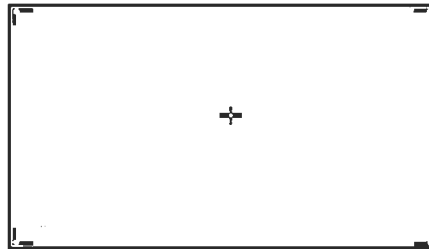

- 2) Press 1st -> 2nd -> 3rd -> 4th -> 5th to adjust the touch sensitivity.
- 3) And it will show the [Return] sign on the screen. Press it to reset the LCD adjustment. After that, the previous source screen will be displayed.
- 4) Try pressing each icon to make sure it works well. If not, repeat the adjusting the Touch screen procedure once again.

7. APPENDIX

■ TROUBLE SHOOTING

GENERAL	Problem	Cause	Measure
	Power does not turn on. (No sound is produced.)	Fuse has blown	Replace with a fuse of the same amperage. If the fuse blow again, consult the store you purchased.
		Incorrect wiring	Connect the connector correctly.
	Nothing happens when buttons are pressed. Display is not accurate.	The operating environment is too cold or too hot.	Operate the unit at room temperature.
		The microprocessor has malfunctioned due to noise or other causes.	Power off the unit and power it on.
	Touch screen does not work correctly.	The touch screen is incorrectly aligned.	Adjust the touch screen sensitivity of the LCD Panel.
	The remote control does not work.	Sunlight is interfering with the remote control IR Sensor.	Use this unit where you can avoid the direct sunlight.
		Batteries of remote control are dead or there is no battery in the remote control.	Check the batteries of the remote control unit.

LCD SCREEN	Problem	Cause	Measure
	The image is not displayed.	The parking brake is not pulled or the parking brake wire is not connected.	Check the parking brake is pulled up.
		It is set to monitor-off mode.	Press the [SETUP] button on the unit to display the screen.
	The display is dark.	The brightness control is too low.	Adjust the brightness setting properly.
		The operating temperature is too low.	If temperature inside of the vehicle is under 0 degree, set to a room temperature (25 degree) and check it again.
		The headlight of the vehicle is lit.	The display is made dark at night to prevent the glare.
	Color of the display is light.	The color is not adjusted correctly.	Check that Color and Tint are adjusted properly.
	When other video source is connected, the video image is not good.	Improper NTSC/PAL setting The operating condition is not good	Set the NTSC/PAL properly according to the VTR or other video source.

DISC	Disc cannot be loaded.	Another disc is already loaded.	Eject the disc before loading the new one.
	Sound skips or sound is noisy.	Compact disc is dirty.	Clean the compact disc with a soft cloth.
		Compact disc is heavily scratched or warped.	Replace with a compact disc with no scratches.
	Sound is bad right after power is turned on.	The droplets may form on the internal lens when the car is parked in a humid place.	Let the unit dry about 1 hour with power on.
	Disc cannot play with the display PARENTEL VIOLATION shown.	The View is limited.	Release the view limitation or change the parental level. See the subsection on Set Up menu on DVD mode.

TV	When the TV tuner is connected, the image gets unclear.	Bad receiving condition.	A radio wave may not reach sufficiently due to obstruction of mountains or buildings. Check it again at a place where a radio wave can be received properly.
	The TV tuner has spots or stripes in the image.	Presence of jamming	It may be under the influence from automobiles, streetcar, power cable, neon sign, and so forth. Check it again after changing place.
SOUND	No sound is heard.	The volume is set to low.	Turn up the volume.
		Speaker wires are not connected correctly.	Connect the speaker wires correctly.
		It is set to mute mode.	Check to see if it is set to mute mode.
	No sound is heard from a speaker.	In the DVD setup, a speaker is set to OFF.	In the audio setup for DVD, change the setting to the appropriate value.
The Balance/Fader setup is incorrect.		In The DVD speaker setup, set the center speaker to OFF.	

SOUND	The front & rear speakers generate different sounds.	In the Zone setup, the front & rear speakers have different sources.	Change the Zone settings.
DVD	DVD does not play.	A DVD disc with a different region setting has been used.	Use DVD titles with the same region number as on the unit.
	Parental protection mode is displayed, and DVD does not play.	The parental protection mode is enabled.	Disable the parental protection mode or change the parental protection level.
	DVD pauses during playback.	It is a dual-layered disc.	It is normal for dual-layered discs to pause during playback and resume.
MP3	MP3 files do not play.	The disc storage standard is incorrect.	Make sure that the disc has stored the MP3 files according to ISO9660 Level1/Level2 Standards.

■ Specifications

Monitor

Screen Size : 6.5 inch wide format, 143.4(W) X 79.33(H)
Display Method : TFT active matrix LCD
Pixel count : 336, 960 [1,440(W) X 234(H)]
Color system : NTSC, PAL, SECAM

DVD Player

Playable Disc format : DVD-Video, Audio CD, Video CD, MP3 CD
Playable Disc Type : CD/CD-R/CD-RW/DVD+R/DVD-R/DVD+RW/DVD-RW
Frequency response : Sampling frequency : 96KHz : 20Hz ~ 44KHz
Distortion : 0.3% or less (1KHz)
Signal-to noise ratio : 80dB(1KHz) or higher (IHF-A)
Digital Output format : Dolby Digital

FM Tuner

Receiving frequency range :
87.5MHz ~ 108.0MHz, 50KHz Step(Europe)
87.5MHz ~ 108.0MHz, 100KHz Step
(USA1, Latin America, Korea/Australia)
87.5MHz ~ 107.9MHz, 200KHz Step(USA2, USA2)
76.0MHz ~ 90.0MHz, 100KHz Step(Japan)
65.0MHz ~ 74.0MHz, 30KHz Step(OIRT)
Usable sensitivity : 12dB or lower
Stereo separation : 25dB(98.1MHz) or higher
Frequency response : 30Hz ~ 10KHz

AM Tuner

Receiving frequency range :
530KHz ~ 1620KHz, 10KHz step(USA1,, USA2)
530KHz ~ 1720KHz, 10KHz Step(USA3)
522KHz ~ 1620KHz, 9KHz Step(Europe)
522KHz ~ 1629KHz, 9KHz Step(Japan)
520KHz ~ 1620KHz, 5KHz Step(Latin America)
531KHz ~ 1602KHz, 9KHz Step(Korea/Australia)
Usable Sensitivity : 33dB or lower

LW Tuner

Receiving frequency range :
144KHz ~ 288KHz, 1KHz Step (Europe)
Usable sensitivity : 33dB or lower

TV Tuner

Color System : NTSC, PAL, SECAM
Receiving channels :
VHF2~13Ch, UHF14~69Ch,NTSC-M
VHF1~20Ch, UHF21~69Ch, PAL-BG(CCI1, Italy)
VHF1~20Ch, UHF21~69Ch, PAL-I/(Ireland, Great Britain)
VHF1~20Ch, UHF21~69Ch, PAL-DK(OIRT)
VHF1~12Ch, UHF13~69Ch, PAL-DK(China)
VHF1~19Ch, UHF20~69Ch, PAL-BB(Australia)
Antenna Input : 75, 4-Ch Diversity

Audio Amp

Rated Power Output (10% Output) : 20WX4Ch(1KHz, 4 Ohm)

Maximum Power Output : 50W * 4Ch

Speaker Impedance : 4Ohm ~ 8Ohm

Bluetooth Handsfree (OPTION)

Core Version : Bluetooth V1.2

Support : Bluetooth built in phone(Bluetooth Headset/Bluetooth Stereo Handsfree)

Reachable distance : Class 2

Additional function : MP3 player of the Bluetooth Phone

General

Power Input Voltage : 14.4V (10.5~16V allowable)

Current consumption : 4.0A (1W)

Operating temperatures : -10 degree ~ +60 degree

Storage temperature : -30 degree ~ +85 degree

Size

178mm(W) X 100mm (H) X 183mm(D)

Weight : 2.6KG

■ Installations & Connections

Installation

[DANGER] : Installation

Information regarding the installation of this unit is intended primarily for experienced installers. The company is not responsible for any problems caused by amateur installation.

Wrap all the wires securely using wiring clamps or insulating tape.

Do not drill through the bulkhead between the engine and the interior to connect this unit's yellow power cable to the car battery. Doing so could fray the cable's insulation, causing this unit to malfunction or be damaged. The hole could also transmit exterior or engine noise to the interior.

When installing this unit's connection cables, be careful not to let them interfere with moving parts such as the gear shift, handbrake, or seat adjustment mechanism. The cables could obstruct normal driving, leading to accidents.

Do not shorten the connection cables included in this unit. Doing so could cause the product's protection circuit to malfunction.

This unit must be connected to a 12V DC battery with negative grounding.

Before you connect this unit to SUV, trucks or buses, check their battery voltage. If the voltage is different, use a transformer to adjust the voltage

before using this unit.

Before you connect the battery cable, be sure to power off this product. Failure to do so could cause an electric shock or short circuit.

Do not install this product's connection cables near to a heater or other source of heat. Doing so could lead to loss of cable insulation, causing this unit to malfunction or be damaged.

Do not connect the power supply cable any other equipment. Doing so could cause the current capacity of the connection cable to be exceeded, resulting in fire or damage to this unit.

When replacing the fuse, be sure to use only fuses compliant with the standard marked on the fuse holder. Using any other fuse could cause the current capacity of the connection cable to be exceeded, resulting in fire or damage to the unit.

When you connect speakers to this unit, use only speakers of high power type. The impedance of such speakers is 4~8Ohm, and the minimum rating output is 50~ or higher. If you connect speakers with an output or impedance other than the indicated values, this product or the speakers could be damaged.

When using the ground wire(black colored wire), separate it from other units that consume high current, such as the power amplifier. Failure to do so could cause fire or damage to this product.

Installing the unit

PRECAUTIONS

Choose the mounting location carefully so that the unit will not interfere with the normal driving functions of the driver. Avoid installing the unit where it would be subject to high temperatures, such as direct sunlight or hot air from the heater or where it would be subject to dust, dirt or excessive vibration. Use only the supplied mounting hardware for a safe and secure installation.

MOUNTING ANGLE ADJUSTMENT

Adjust the mounting angle to less than 20°

The following picture shows how to install this unit in the car.

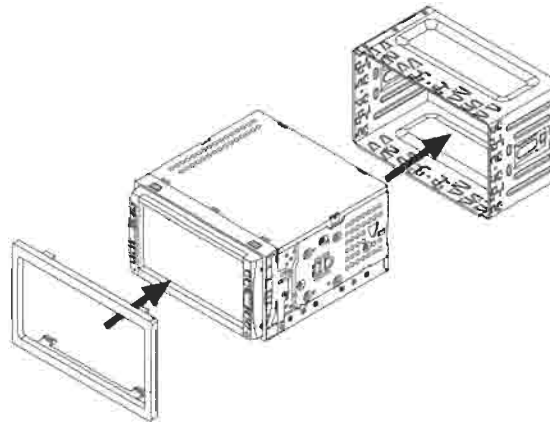

Removing the Unit

- 1) Remove the Trim cover
- 2) Insert the Split bar between the spring and the Half Sleeve Mounting bracket.
- 3) Use the split bar to remove this unit.

[CAUTION] :

Keep the Split bar in a safe place. The unit cannot be removed without it.

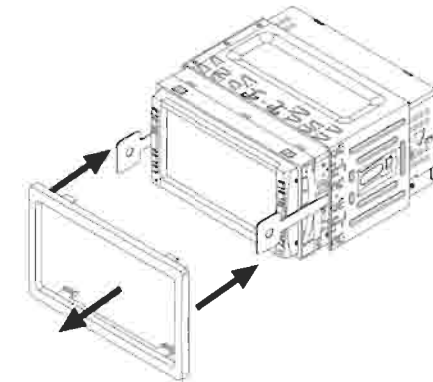

System Connection

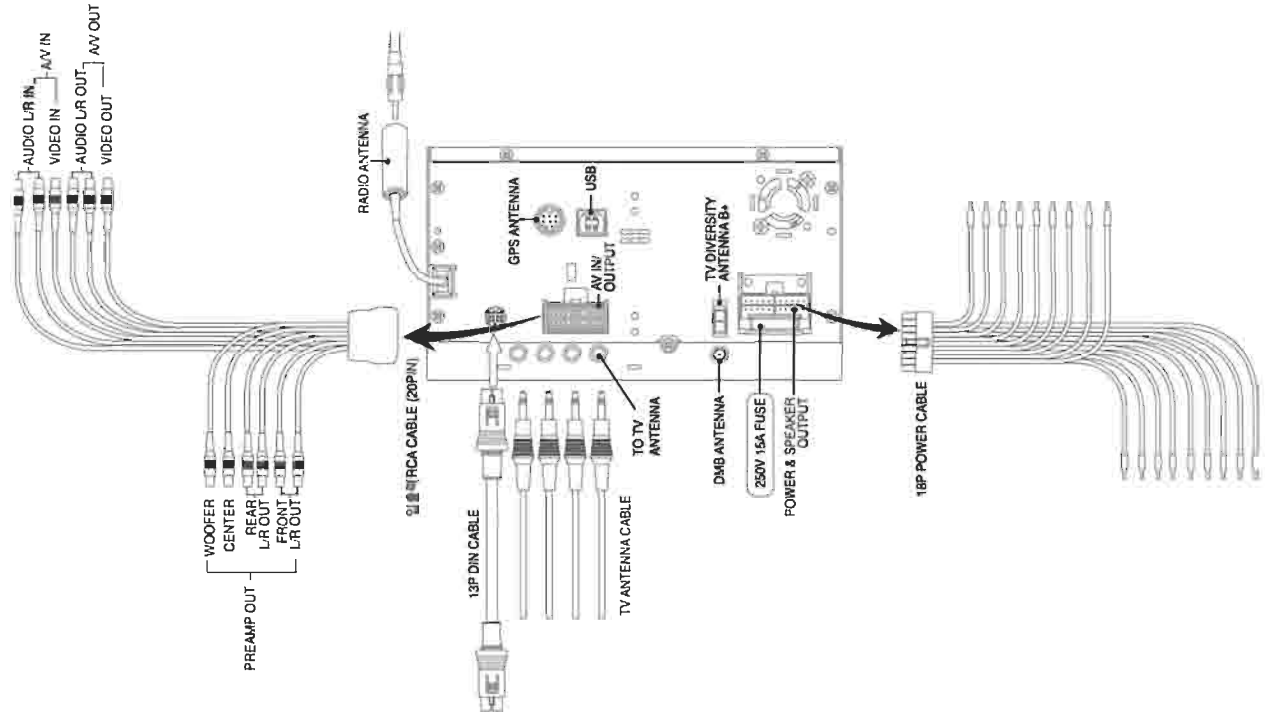

Power Connection

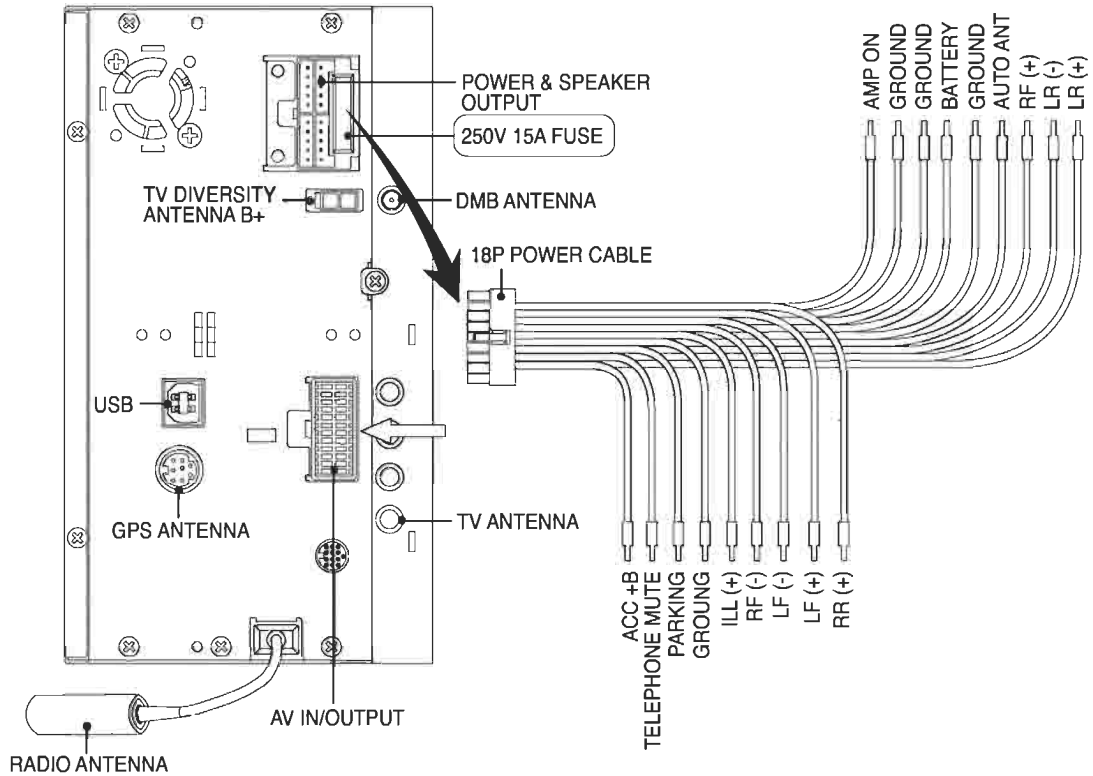

Installing external Navigation

To connect an external car navigation system to this unit, proceed as below.

- The navigation system which has 13 pin RGB connector.

Use the dedicated 13 pin Navigation cable to connect the navigation system to this unit. For 13 pin Navigation connector pin configuration, refer to the page 67.

Connecting the Navigation System

Use the dedicated 13-pin Navigation cable to connect to a Car Navigation System.

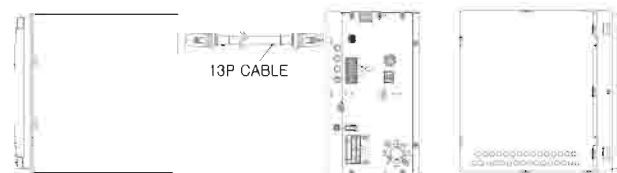

User Interface for navigation setup



NAVI function should be set to "NAVI ON and AUTO" on SET UP-ETC-EXTERN-EXT3 MODE to operate the navigation system.

[CAUTION] : 13PIN RGB Connection to the external NAVIGATION

Before you connect this Product to a navigation system, check the installing external navigation system carefully.

Using a navigation system connecting to this unit using the dedicated 13 pin Navigation cable could cause the product or the navigation system itself to fail. If either the system or this product fails in this way, it is considered to be the responsibility of the user and not eligible for warranty.

● Normal NAVIGATION System

This product can be connected to a navigation system through CVBS Video connector and mono audio connector.

Connect the NAVIGATION system which has mono audio output and CVBS Video output to AV Input of this unit.

User Interface for navigation setup



NAVI function should be set to "NAVI ON & CVBS ONLY" on SET UP-ETC-EXTERN-EXT3 MODE and to operate the navigation system

Navigation Connector Pin Configuration

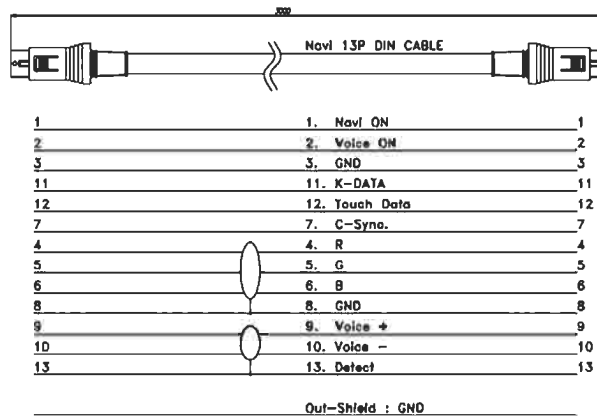

Socket Configuration

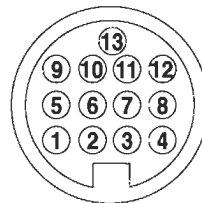

NO	PIN DATA	SPECIFICATION	DIRECTION
1	NAVI ON	DC+5V POWER DETECT	OUT
2	VOICE ON	MUTE SIGNAL (+5V : ACTIVE, 0V : MUTE)	OUT
3	GROUND	GROUND	
4	RED OUT	75OHM, 0.7Vp-p	OUT
5	GREEN OUT	75OHM, 0.7Vp-p	OUT
6	BLUE OUT	75OHM, 0.7Vp-p	OUT
7	CSYNC	TTL LEVEL	OUT
8	VGND	VIDEO GROUND	OUT
9	AUDIO OUT-L	500mVrms(Load 47Kohm, 1KHz)	OUT
10	AUDIO OUT-R	500mVrms(Load 47Kohm, 1KHz)	OUT
11	KDATA(REMOCON SIGNAL BY-PASS)	TTL LEVEL	IN
12	TOUCH DATA (RX, UART)	TTL LEVEL	IN
13	DETECT(GND)	GROUND	OUT

■ Components

1) Main Unit

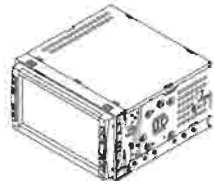

4) Mounting Bracket



7) Remote Control



10) Machine Screw 8EA



2) Power Connector



5) Trim Cover



8) Battery(AAA Type) 2EA



3) AV Input/Output Cable



6) Split Bar



9) User's Manual

